



JIABO 佳博

杭州佳博精密机械制造有限公司

HANGZHOU JIABO PRECISION MACHINERY MANUFACTURING CO.,LTD



佳博让流体更精彩...

佳博让流体更精彩...

company profile
理念文化

精益求精 合作共赢



Our aim:
Exquisite technology, to create first-class quality
Quality services, won the first-class reputation
Our character:
Keep dreaming, exploration and innovation
Our style:
Stable solid dry, create brilliant
Our belief:
Dedicated enterprise, scaled new heights

我们的宗旨:
以精湛技术, 创造一流品质
以优质服务, 荣获一流信誉
我们的性格:
敢想敢拼、开拓创新
我们的作风:
稳扎实干、共创辉煌
我们的信念:
奉献企业、勇攀高峰



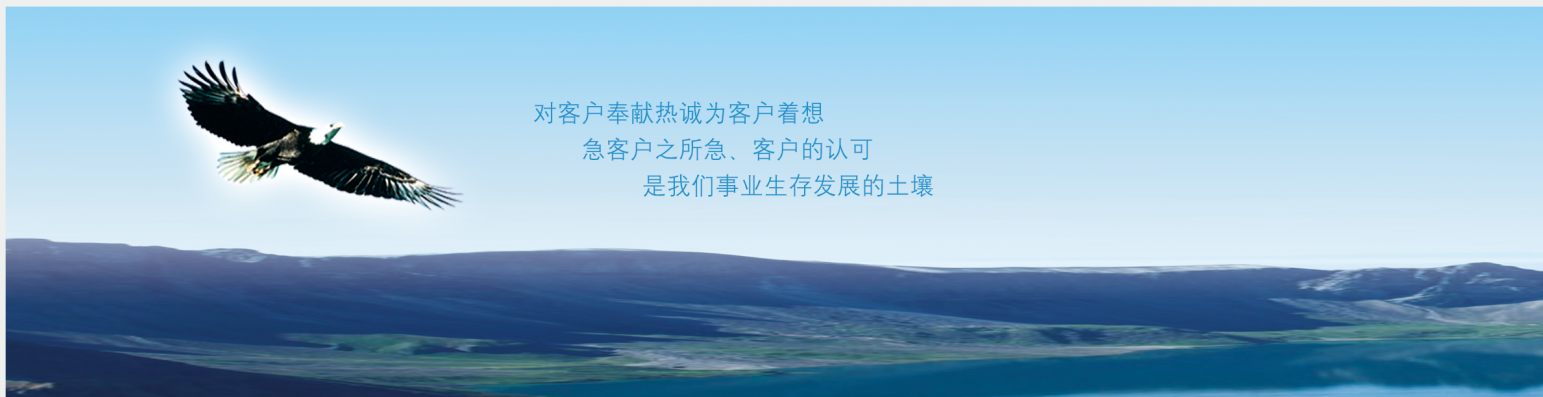

对客户奉献热诚为客户着想
急客户之所急、客户的认可
是我们事业生存发展的土壤

company profile 公司简介

杭州佳博精密机械制造有限公司主要生产研制自动化设备、智能流体机械、智能机器人、并为半导体设备、智能楼宇系统、石油钻探提炼设备、电力设备等行业提供设备组装件、精密零件、高精焊接件。

杭州佳博精密机械制造有限公司全体员工以“精益求精、合作共赢、力求更好、持续改进”为基本原则，诚心为客户提供高品质的产品和最好的服务！

Hangzhou Jiabo Precision Machinery Manufacturing Co. Ltd is specialized in the development of automation equipment, intelligent fluid machinery, intelligent robot, and semiconductor equipment, intelligent building systems, oil drilling, refining equipment, electrical equipment and other industries to provide equipment assembly, precision parts, high precision welding parts.

Hangzhou Jiabo Precision Machinery Manufacturing Co., the company all staff to "strive for excellence, win-win cooperation, and strive to better, continuous improvement" as the basic principle, sincerely provide high quality products and best service for customers!

精益求精 合作共赢

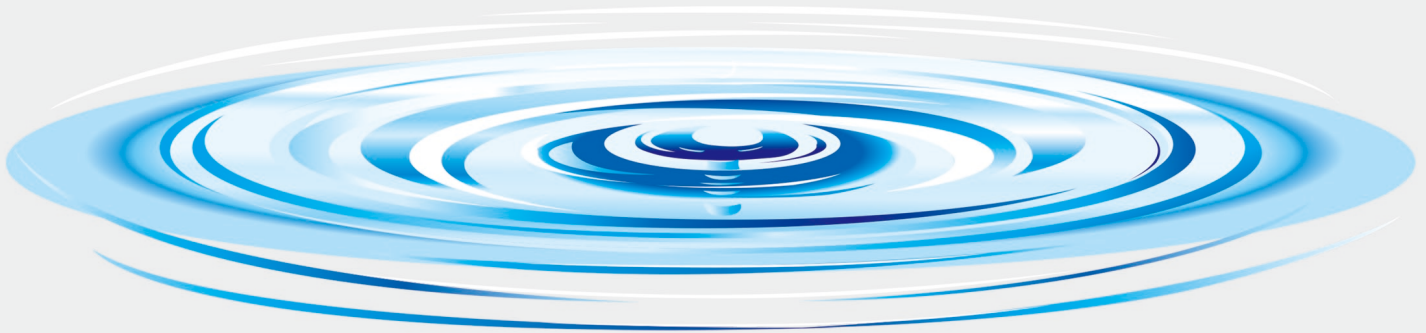
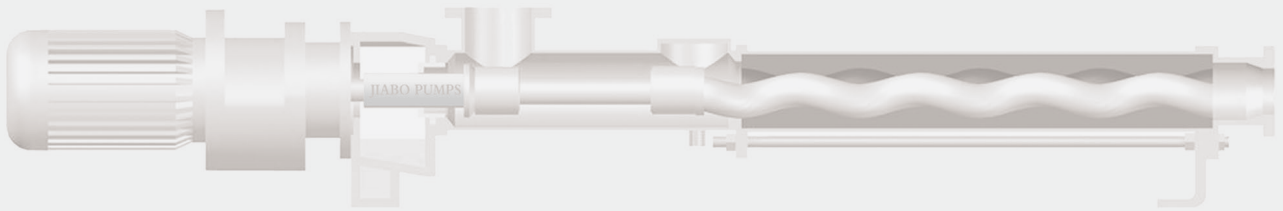
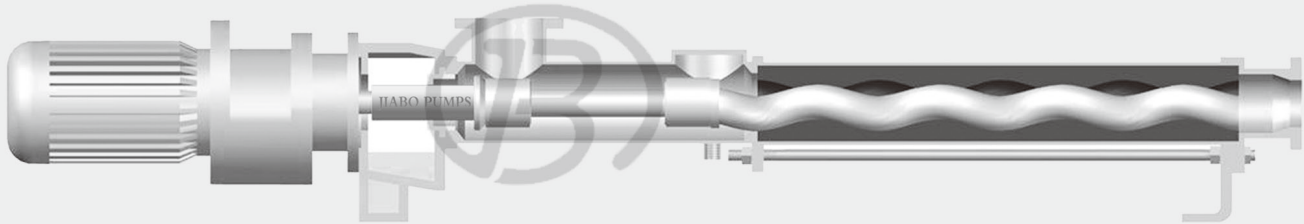

company profile

活力团队

团队的核心是共同奉献

我们拥有一支团结一致的队伍，
为企业目标而坚毅奋斗到底的一流人才。
团队不仅强调个人的业务成果，
更强调团队的整体业绩。

古人云：人心齐，泰山移

这种共同奉献需要每一位员工能为之信服的目标，
要切实可行而又具有挑战意义的目标，
能激发团队的工作动力和奉献精神
为企业注入生命活力。

A man's life is only three days, yesterday, today and tomorrow.
Tomorrow may be glorious, but it is past;
Tomorrow will be glorious, but search for it;
Only today, Only here today, is the inheritance and sustenance
post tomorrow. The huayu tube piece has passed by yesterday,
And the belief that we need to be
steadfast in our spirit and win.
Honesty, innovation, learning win-win, market reputation,
smile to face tomorrow.

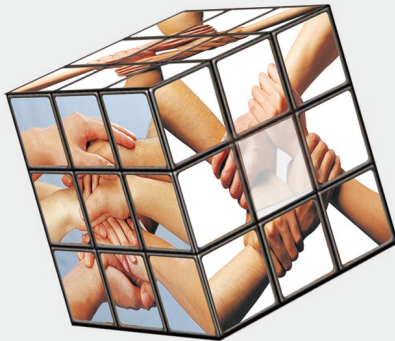

精益求精 合作共赢



The only one is broad and profound

独此一 **佳博** 大精深

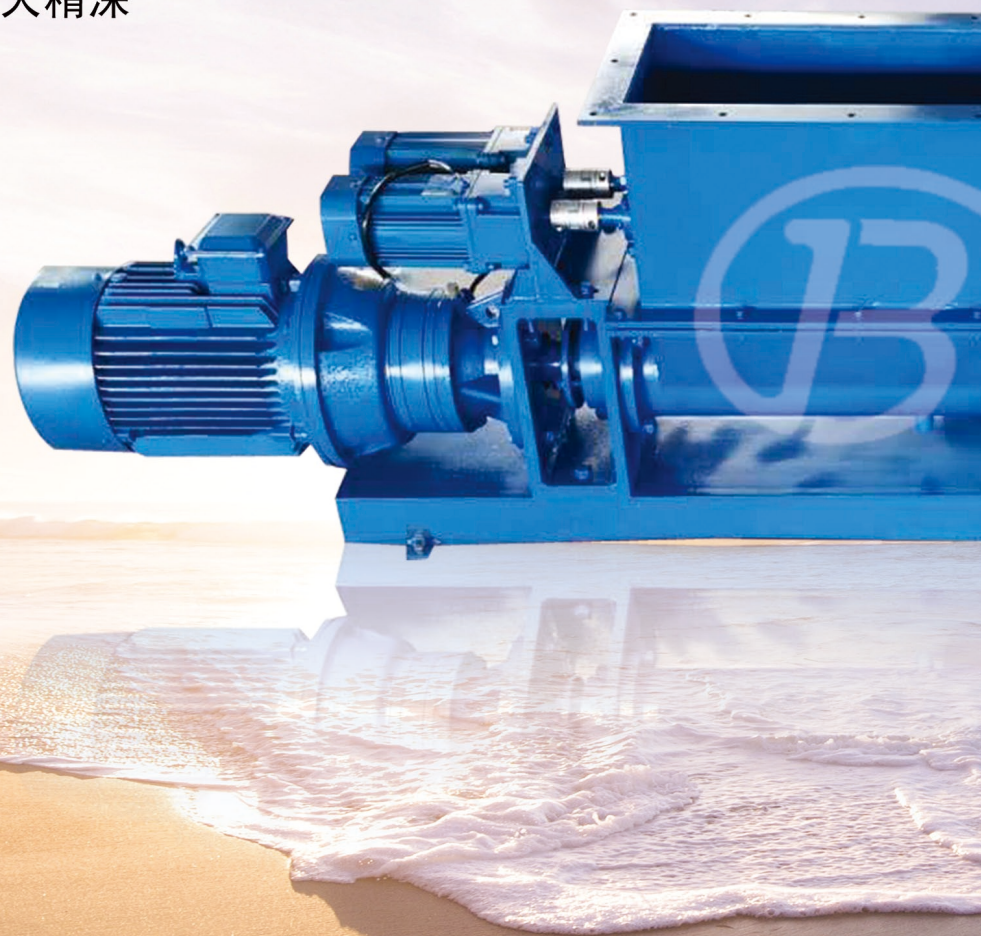

精益求精 合作共赢



产品系列 Product Series

1 直联式

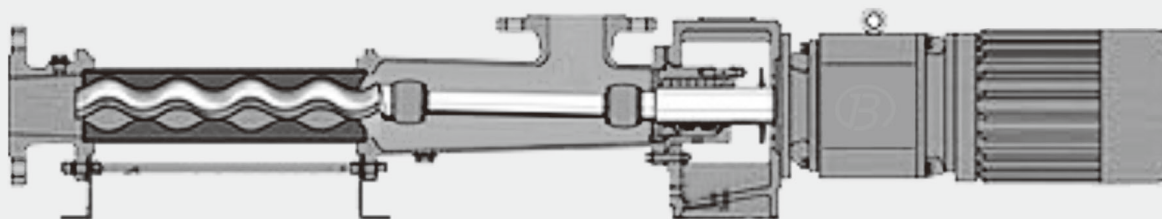

- 特点：驱动系统与泵直联，结构紧凑，泵长度较短，性能稳定。

驱动系统与泵的连接轴通过轴销连接，易于维修拆卸。

- 参数：最大流量 $280\text{m}^3/\text{h}$ ；最大压力 2.4MPa 或更高。
- Features: the speed reducer is driven directly, the structure is compact, and the pump length is short. The connecting shaft of the deceleration motor and the pump is connected through the shaft pin, which is easy to repair and disassemble.
- Parameters: maximum flow rate $280\text{m}^3/\text{h}$ and maximum pressure of 2.4MPa or higher.



产品系列

Product Series

2 轴承座联轴器式

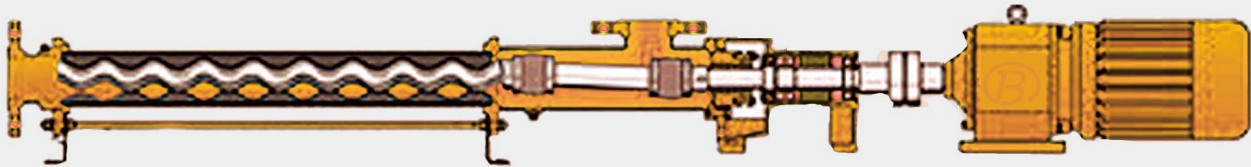

- 特点：驱动电机通过轴承座驱动，承载能力强，刚性好。
- 参数：最大流量600m³/h；最大压力4.8MPa或更高。
- Characteristics: the deceleration motor is driven by the bearing seat, and the bearing capacity is strong and the rigidity is good.
- Parameters: maximum flow rate 600m³/h and maximum pressure of 4.8MPa or higher.

产品系列

Product Series

3 卫生食品式

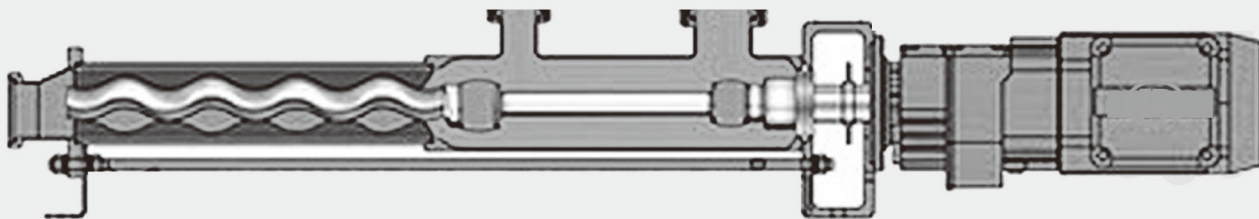

- 特点：适用于有清洁卫生要求的食品、医药、化妆品及生物工程中各种物料的输送，用全不锈钢材料，过流表面经抛光、易清洗。
- 参数：最大流量200m³/h；最大压力2.4MPa或更高。
- Features: applicable to food, medicine, cosmetics and bioengineering with clean and hygienic requirements All kinds of materials are transported with all stainless steel materials, the overflow surface is polished and easy to be cleaned.
- Parameters: maximum flow rate 200m³/h and maximum pressure of 2.4MPa or higher.

产品系列 Product Series

4 破桥式

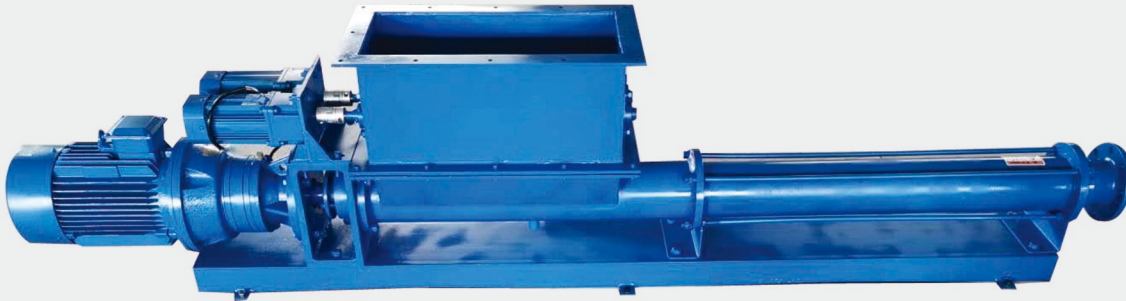

- 特点：用于输送有“搭桥”效应的非流动性物料；吸入室带加大矩形进料斗。
- 参数：最大流量100m³/h；最大压力4.8MPa或更高。
- Features: it is used to transport non - liquid materials with "bridge" effect.The suction chamber is used to increase the rectangular hopper.
- Parameters: maximum flow rate 100m³/h and maximum pressure of 4.8MPa or higher.

产品系列

Product Series

5 微型计量泵

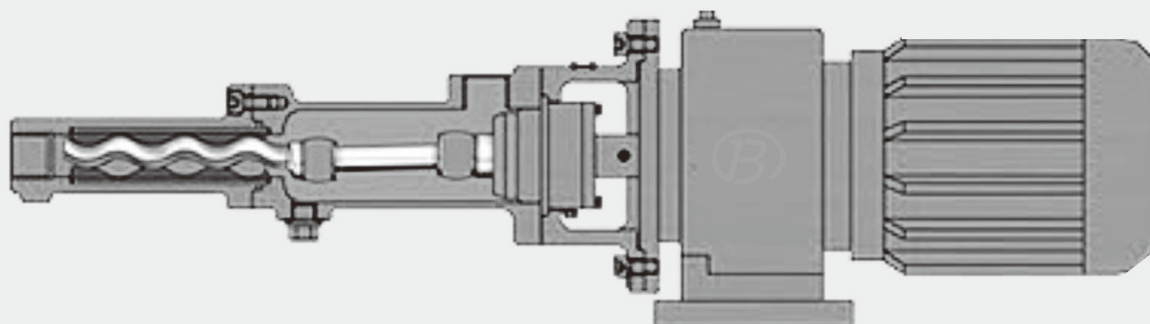

特点：适用于小流量输送粘稠物料，带调速装置可用于化学介质计量投加。

参数：最小流量0.03L/min；最大压力2.4MPa或更高；计量误差可控制在 $\pm 1\%$ 。

- Features: suitable for small flow of viscous material, with speed control device can be used for chemical medium measurement and addition.
- Parameters: minimum flow rate 0.03L/min; maximum pressure of 2.4MPa or higher; measurement error can be controlled in 1%.



产品系列 Product Series

6 背包式

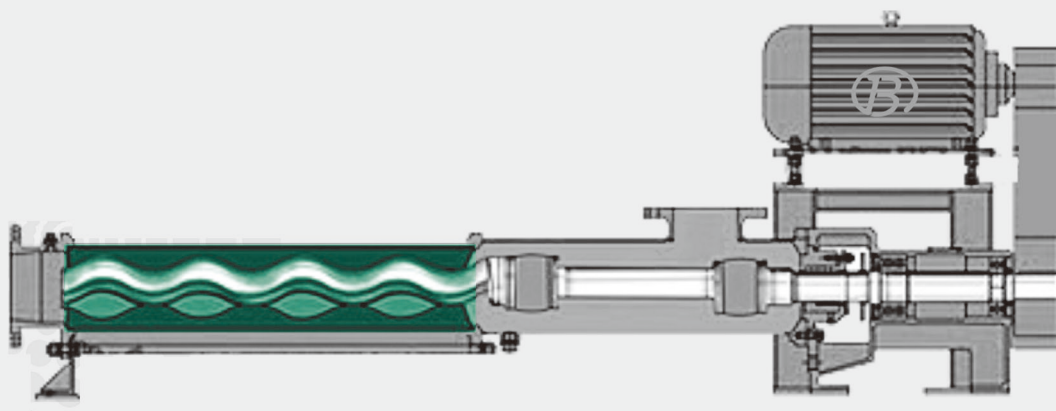

特点：电动机置于泵的上方，通过齿形带传动并减速，可以有效缩短泵的长度。

参数：最大流量200m³/h；最大压力2.4MPa或更高。

- Features: the motor is placed above the pump and is driven and decelerated through the tooth belt. It can effectively shorten the length of the pump.
- Parameters: maximum flow rate 200m³/h and maximum pressure of 2.4MPa or higher.



产品系列

Product Series

7 立式液下式螺杆泵

• 特点

占地面积小

泵工作部件可插入液下，吸入能力强

适合高粘度、高浓度流体的抽送

可用于筒、罐、池、井、涵洞等场所

流量可达 200m³/h;

压力可达 4.8MPa

工作温度 ≤150 °C ;

• 结构形式

- 有基座式、壁挂式、吊装式、插桶式

等多种安装形式

- 通常为直连式（无轴承座）结构，亦

可佩带轴承座

- 可采用机械密封或填料密封

Characteristic

Small areaThe working parts of the pump can be inserted into the liquid, and the suction ability is strong.Suitable for high viscosity, high concentration fluid pumpingIt can be used in a tube, a tank, a pool, a well, a culvert, etc.The flow rate is up to 200m³/h;Pressure up to 4.8MPaThe working temperature is less than or equal to 150 or C;

structural style

There are many kinds of installation forms, such as base type, wall hanging type, hoisting type, barrel type and so onIt is usually a direct connection (no bearing seat) structure or bearing bearing seatMechanical seal or packing seal can be used

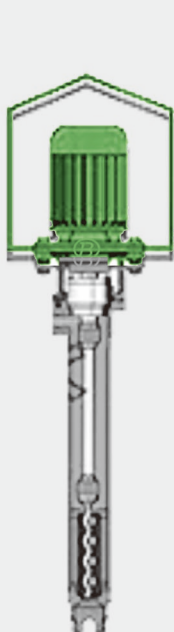

吊装式



插桶式



挂壁式

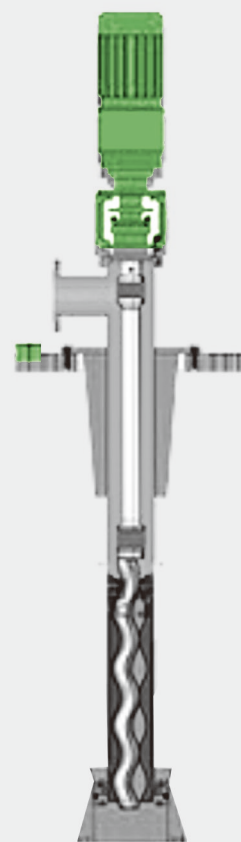

基座式

产品系列

Product Series

8 车载式



特点：泵置于移动小车上，有立式、卧式和搅拌式。

参数：最大流量 $50\text{m}^3/\text{h}$ ；最大压力 2.4MPa 或更高。

- Features: the pump is placed on the mobile trolley with vertical, horizontal and stirred types.
- Parameters: maximum flow rate $50\text{m}^3/\text{h}$ and maximum pressure of 2.4MPa or higher.



产品系列 Product Series

9料斗型螺杆泵

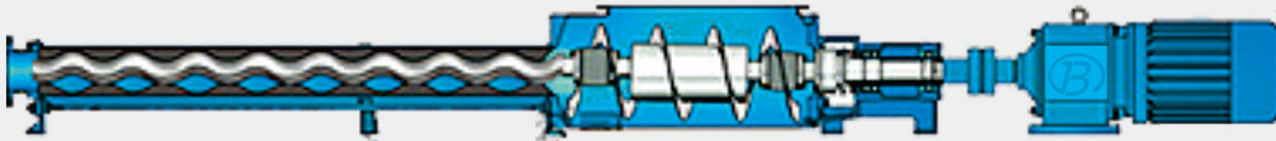

特点：适用于输送浓缩、脱水污泥等非流动性物料，物料需要在螺旋送料器的推动下可顺利地推入吸入口，吸入室带矩形进料斗。

参数：最大流量100m³/h；最大压力4.8MPa或更高。

- Features: suitable for transporting concentrated and dewatered sludge and other non flowable materials, materials needed in the spiral feederThe suction chamber is successfully pushed into the suction mouth and the suction chamber is carried with a rectangular hopper.
- Parameters: maximum flow rate 100m³/h and maximum pressure of 4.8MPa or higher.



应用领域

Application area

1 环保工程

在污水处理流程中，浓缩污泥、脱水污泥、干化污泥，以及化学添加剂的输送作业，都会使用到我们的产品。例如板框压滤机、带式压滤机、离心脱水机系统。

In the sewage treatment process, the concentrated sludge, dehydrated sludge, dry sludge, and chemical additives will be used for the delivery of our products. For example, the plate frame filter press, the belt filter press and the centrifugal dehydrator system.





应用领域 Application area

2 化工业、造纸及纸浆

在造纸工艺流程中，各阶段的浆料、助剂、颜料以及胶粘剂通常选用单螺杆泵进行输送，它们的粘性与精确的计量均要求输送设备的性能正是佳博精机单螺杆泵所具备的。

In papermaking process, each stage of the slurry, additives, pigments and adhesive usually use single screw pump for conveying, their viscosity and precision measuring performance requirements of transmission equipment is Gpilot precision machine with single screw pump.





应用领域

Application area

3 食品制药



食品饮料行业用泵

食品饮料在新鲜的时候是最好的，闻起来特别好，看起来特别具有食欲。“佳博精机”泵能够以清洁、平稳的方式将高级介质在整个加工阶段进行输送。我们的泵为您的生产工艺开辟了新可能。针对高粘度的介质，我们提供带有螺旋“佳博精机”泵，以便进行平稳地处理介质。

针对各种应用需求的最佳解决方案

食品饮料行业中的应用要求需要不同的泵系统。佳博工业转子泵和单螺杆泵均可为您的工艺提供最佳解决方案。

针对一些应用情况，使用工业转子泵和单螺杆泵均可。佳博作为两种泵技术的生产商，将提供全面的、权威的建议，使得泵技术最适合于您的应用要求。

Pump for food and beverage industry

Food and drink are the best when they are fresh. It smells especially good and looks particularly appetizing. "Gpilot fine machine" to pump clean and smooth the way the senior media are transported throughout the processing stage. Our pump has opened up a new possibility for your production process. For high viscosity medium, we provide a "Gpilot Seiki" spiral pump, in order to smooth processing medium.

The best solution for various application requirements

The application of the food and beverage industry requires different pump systems. Gpilot industrial rotor pump and single screw pump can provide the best solution for your process.

In view of the application situation, the industrial rotor pump and the single screw pump can be used. Gpilot as two pump technology manufacturers, will provide comprehensive and authoritative advice, make the pump technology best suited to your application requirements.

精益求精 合作共赢





应用领域

Application area

4 石油化工

泵系统的可靠性是优良操作性能的保证

当今世界对能源的需求不断增加。这一部分是由于发展中国家强力推动工业化。但是，由于原油越来越稀少，原油冶炼变得越来越复杂。而随着悬浮固体颗粒比例越来越大以及水和气体含量越来越高，原油的粘度也大幅增加。佳博精机的创新技术，保证全寿命周期低成本条件下安全可靠的生产过程。我们的产品系列种类广泛，保证为您提供完美的泵系统满足您近海或海上、深井泵或地面泵应用。

佳博泵遵守最高质量要求，保证满足客户日益增长的环保要求。

The reliability of the pump system is the guarantee of excellent operating performance

The demand for energy is increasing in the world today. This part is due to the strong promotion of industrialization by developing countries. However, as crude oil is less and less, the refining of crude oil becomes more and more complex. With the increasing proportion of suspended solid particles and the increasing of water and gas content, the viscosity of crude oil also increased greatly.

Gpilot precision machine technology, ensure the production process of whole life cycle under the condition of low cost and reliable safety. We have a wide range of products to provide you with a perfect pump system to meet your offshore or offshore, deep well pump or ground pump applications. Gpilot pump comply with the highest quality requirements, to ensure customer satisfaction, increasing environmental requirements.

精益求精 合作共赢





应用领域

Application area

5 钢铁冶金

冶金钢铁行业是国家重工业发展的基础行业。在过去的二十年中，不仅有幸见证了中国冶金钢铁行业的飞速发展，更凭借专业的螺杆泵产品和服务，积极投身于国内冶金钢铁行业发展中去，创造了巨大的贡献。在冶金钢铁行业的冷轧\热轧循环油系统，磨煤机润滑系统、润滑脂输送、污水处理等应用中，以高质量的螺杆泵产品和服务成为众多用户的首选。

目前，几乎与所有国内各大钢铁企业建立了长期的合作关系，包括宝钢、首钢、马钢、武钢、重钢、攀钢、鞍钢等。

The metallurgical steel industry is the basic industry for the development of national heavy industry. In the past two decades, it has not only been fortunate to witness the rapid development of China's metallurgical steel industry, but also to actively contribute to the development of the domestic metallurgical steel industry with professional screw pump products and services, and has made tremendous contributions. In the cold rolling / hot rolling cycle oil system of the metallurgical steel industry, coal mill lubrication system, grease transportation, sewage treatment and other applications, high quality screw pump products and services have become the first choice for many users.

At present, it has established long-term cooperative relationships with all major domestic steel companies, including Baosteel, Shougang, Maanshan Iron and Steel, Wuhan Iron and Steel, Chongqing Iron and Steel, Panzihua Iron and Steel, and Anshan Iron and Steel.

精益求精 合作共赢





应用领域

Application area

6 船舶制造

船舶设计和制造为人类的发展历史，发挥了巨大的作用。持续关注船舶行业的用户需求，以更符合船舶行业特点的螺杆泵产品，不断为船舶行业的发展“添砖加瓦”。在机舱系统的燃油、滑油、油污水处理模块，甲板机械的液压模块，货油装卸系统，螺旋桨推进系统中，可以为您提供更合适的解决方案。

目前，已与多家国内外多家知名船厂和船东建立了良好的合作关系，包括中船重工、上海船厂、广船国际等，并为一些船舶主机制造商提供螺杆泵方案。

Ship design and manufacturing have played a huge role in the history of human development. Constantly paying attention to the needs of users in the shipbuilding industry, the screw pump products that are more in line with the characteristics of the shipbuilding industry are constantly adding to the development of the shipbuilding industry. In the cabin system fuel, oil, oil sewage treatment module, deck machinery hydraulic module, cargo handling system, propeller propulsion system, can provide you with a more suitable solution.

At present, it has established good cooperative relations with many well-known shipyards and shipowners at home and abroad, including CSIC, Shanghai Shipyard, Guangzhou Shipyard International, etc., and provides screw pump solutions for some ship host manufacturers.

JIABO JINGJI

精益求精 合作共赢



应用领域

Application area

7 电力

电力是社会经济发展的重要能源和推力。一直致力于螺杆泵产品的研发和制造，并成功为电力行业提供了数以万计的专业产品和服务。在火电、水电、风电、核电领域，螺杆泵产品应用于燃油运载、润滑、顶轴液压、污水处理等系统模块。

目前我们已经与多家国内外知名电力主机设备制造商建立长期稳定的合作关系，包括上海电气，东方电气，哈尔滨电气等，并已成功进入核电领域，为中国核电事业发展提供可靠的螺杆泵解决方案。

Electricity is an important source of energy and thrust for social and economic development. Has been committed to the development and manufacture of screw pump products, and successfully provided tens of thousands of professional products and services for the power industry. In the fields of thermal power, hydropower, wind power and nuclear power, screw pump products are used in system modules such as fuel transportation, lubrication, top shaft hydraulics, and sewage treatment.

At present, we have established long-term and stable cooperative relations with many well-known power host equipment manufacturers at home and abroad, including Shanghai Electric, Dongfang Electric, Harbin Electric, etc., and have successfully entered the nuclear power field to provide reliable screw pump solutions for the development of China's nuclear power industry. Program.





应用领域

Application area

JIABO JINGJI



8 计量投加应用

特点:

- 1、特别适用于各种超小流量场合。
- 2、计量精确，流量误差 $<2\%$ ，特殊型号小于 0.5% 。
- 3、具有良好的自吸和回吸功能，全面避免介质滴漏、拉丝、过滴等
- 4、输出流量恒定、平稳、无脉动，低剪切，且流量与压力成正比关系，可用作计量投加用。
- 5、应用范围广，适用于各种流体。
- 6、可双相旋转、双相输送，工作噪声小，无温升，运行维护成本低。

Features:

- 1、 especially suitable for all kinds of ultra-small flow occasions.
- 2、 accurate measurement, flow error $<2\%$, special model less than 0.5% .
- 3、 has a good self-priming and suckback function, comprehensively avoid medium drip, wire drawing, dripping, etc.
- 4、 the output flow is constant, stable, no pulsation, low shear, and the flow rate is proportional to the pressure, which can be used for metering and dosing.
- 5、 Wide range of applications for a wide range of fluids.
- 6、 can be two-phase rotation, two-phase transmission, low working noise, no temperature rise, low operating and maintenance costs.

精益求精 合作共赢
Better cooperation and win-win cooperation



杭州佳博精密机械制造有限公司
HANGZHOU JIABO PRECISION MACHINERY MANUFACTURING CO.,LTD

地址：浙江省杭州市富阳区国家级开发区场口园区百丈路
电话：0571-2328 7567
传真：0571-2328 9567
网址：<http://www.chinajiabo.com>

ADDRESS : Hangzhou City, Zhejiang provinceFuyang
District National Development Zone

TEL : 0086-571-2328 7567

FAX : 0086-571-2328 9567

Web : [http://www.chinajiabo .com](http://www.chinajiabo.com)

分公司办事处代理商：

